

<h1>DENKA LIFT</h1> <p>Højvang 5 4300 Holbæk Phone 59 45 55 00</p>	Lift type : JUNIOR 12	No : 12503	Hydraulics : Atos ON/OFF	Dia. No. : 04015606
	Extra equipment: CE MODEL	Approved by : CTJ REGSTRUP AUT	Date : 08-05-02 Rev. :	Title : Schaltplan
Drawn by : MSG				seite :1 of 6

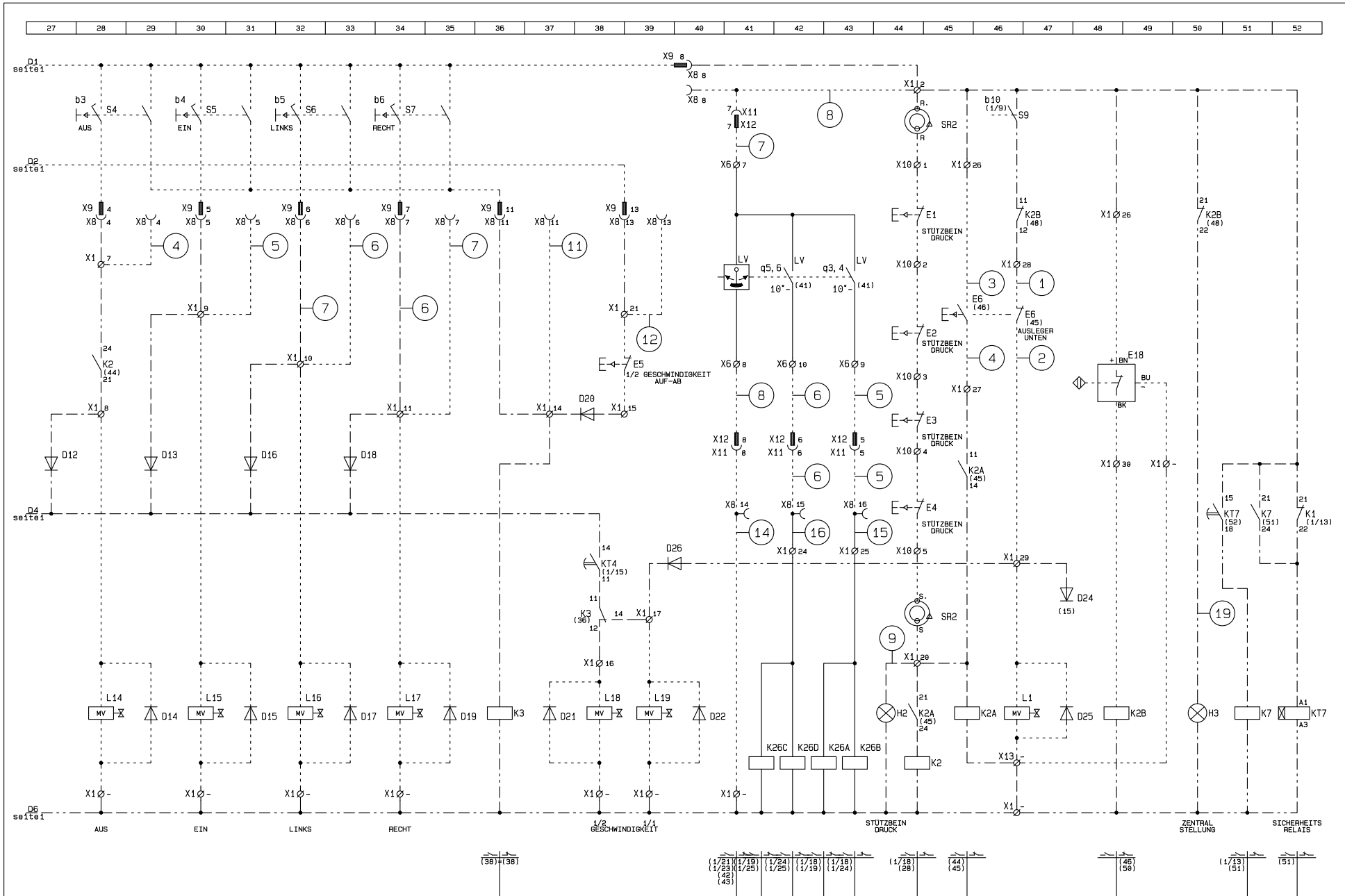

DENKA LIFT	Lift type : JUNIOR 12	No : 12503	Hydraulics : Atos ON/OFF	Dia. No. : 04015606
	Extra equipment: CE MODEL			Title : Schaltplan
Højvang 5 4300 Holbæk Phone 59 45 55 00	Drawn by : MSG	Approved by : CTJ REGSTRUP AUT	Date : 08-05-02 Rev. :	seite :2 of 6

DECKEL AUTOKASTE

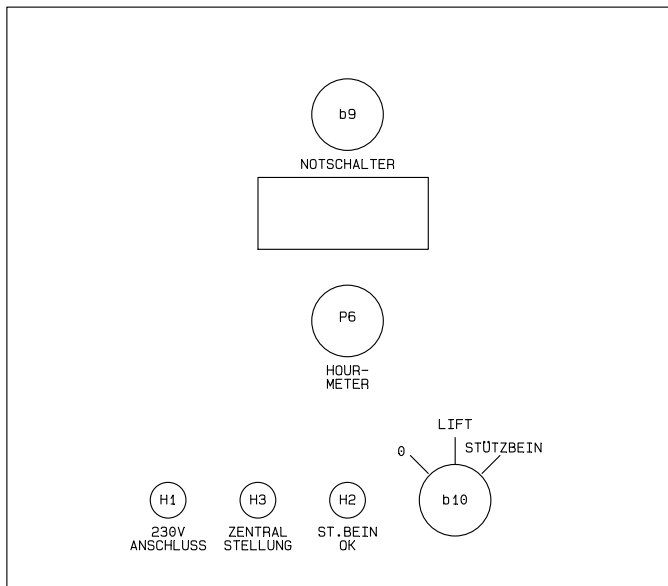

INHALT AUTOKASTE

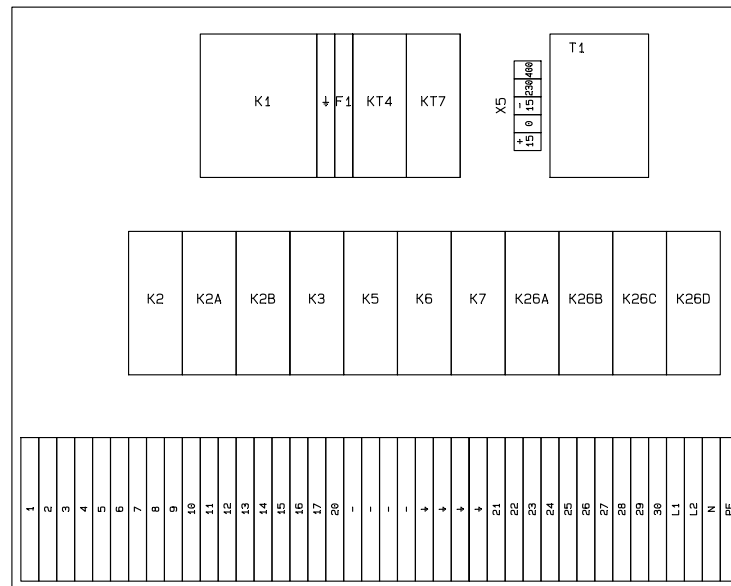

BEDIENUNG

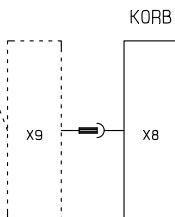
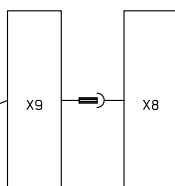
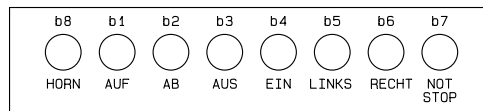

KORB

EL-DOSE AM KORB

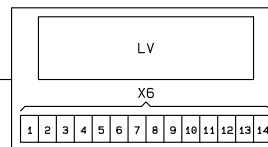

EL-DOSE AM CHASSIS

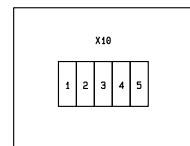

230V ANSCHLUSS AM CHASSIS



EL-DOSE AM CHASSIS

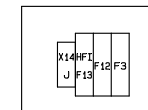

MAGNET VENTILE

L13 KORBHORIZON TIERUNG AB	L18 GESCHWINDIGKEIT 1/2	L15 EIN	L17 RECHT	L12 AB
L11 KORBHORIZON TIERUNG AUF	L19 GESCHWINDIGKEIT 1/1	L14 AUS	L16 LINKS	L10 AUF

— PLATINE
- - - - - STEUERKASTE
- - - - - AUS STEUERKASTE

DENKA LIFT

Lift type : JUNIOR 12	No : 12503	Hydraulics : Atos ON/OFF	Dia. No. : 04015606
Extra equipment: CE MODEL	Title : Positionsplan		seite :3 of 6
Drawn by : MSG	Approved by : CTJ REGSTRUP AUT	Date : 08-05-02 Rev. :	

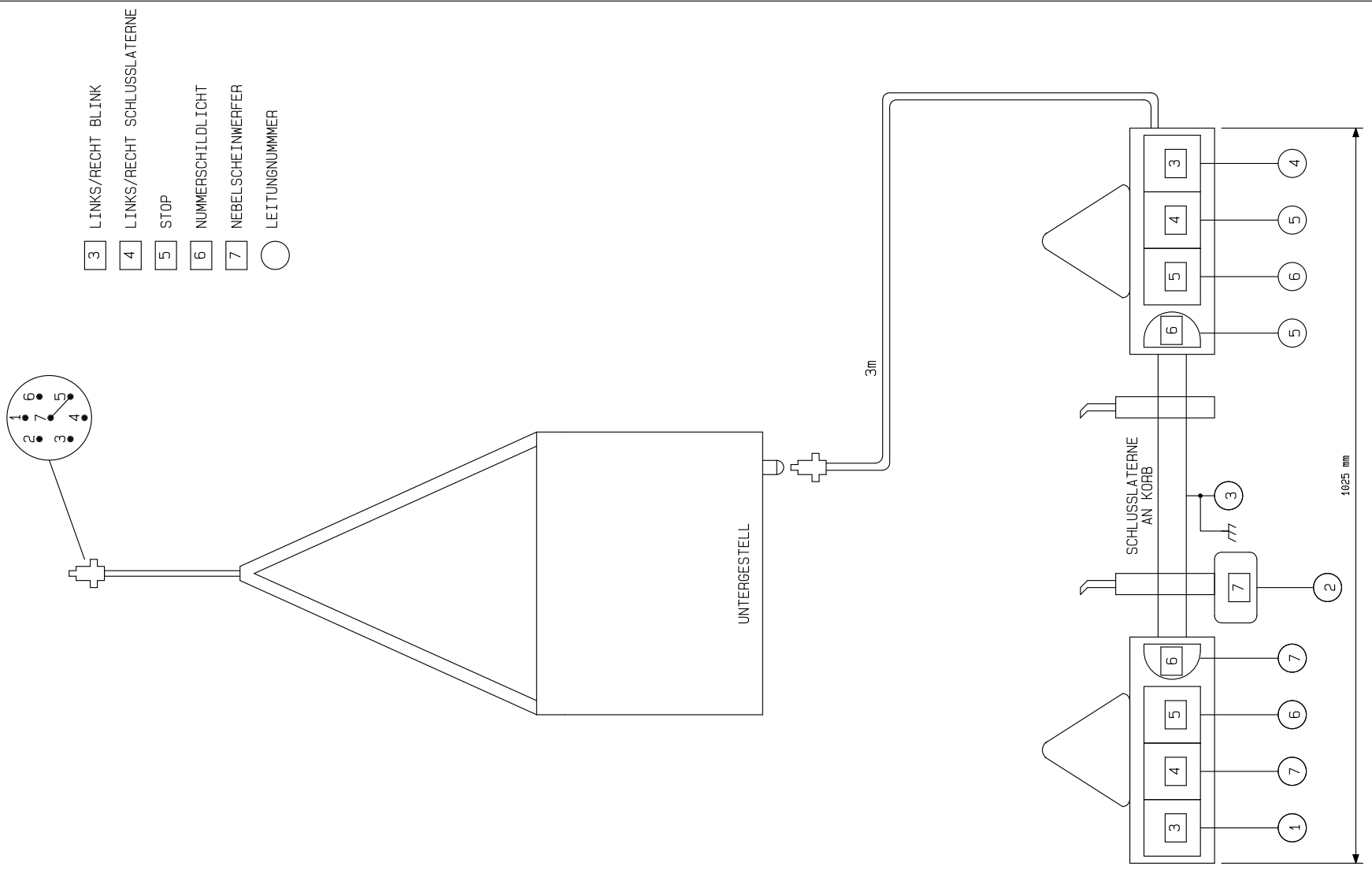

- 3 LINKS/RECHT BLINK
- 4 LINKS/RECHT SCHLUSSLATERNE
- 5 STOP
- 6 NUMMERSCHILDLICHT
- 7 NEBELSCHEINWERFER
- LEITUNGNUMMER

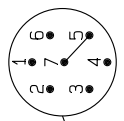

DENKA LIFT Højvang 5 4300 Holbæk Phone 59 45 55 00	Lift type : JUNIOR 12	No : 12503	Hydraulics : Atos ON/OFF	Dia. No. : 04015606
	Extra equipment: CE MODEL	Drawn by : MSG	Approved by : CTJ REGSTRUP AUT	Title : Licht untergestell
			Date : 08-05-02 Rev. :	seite :4 of 6

STÜCKLISTE

Lift type :
 No : 12503
 Extra ausrüstung :

Denka Lift A/S
 Højvang 5
 DK-4300 Holbæk
 e-mail: INFO@DENKA.dk
 Tel. +45 59 45 55 00
 Fax. +45 59 44 21 55

Pos.	Benennung	Teil nr.
C2	Kondensator, e1000µF 63V	03480144
D1, D2, D6, D8, D9, D11..D26	Diode, 1n4007 1000V	03480101
E1..E4	Endschalter, XCM A 1103 M	03090067
E5, E6	Endschalter XCK-P527H29	03090069
E18	Induktiv sensor, XS2N12PB340	03410072
F1	Feinsicherung, 4A	03410005
F3, F12	Automatsicherung, 10A	03410009
F13	Fehlerstromrelais, 2pol 25A 30mA	03410088
G1	Gleichrichter, 25A	03420102
H1..H3	Lampe led grün, ZB4BV033	03090123
H1..H3	Leuchte grün 24VDC/ac led, ZB4BVB3	03090124
H4	Horn, 24V	03080016
K1	Relais 12A 24VDC, LC1D12BD	03090127
K1, K2, K2B, K3, K5	Relais, 2-pol 24V 10A, Schrack RT424024, Finder 4462.9024	03410027
K2A, K3, K6, K7, K26A..K26D	Printrelais 8A 24VDC, RT 424024	03090128
KT4, KT7	Timer multifkt 24-230V, ODQ1	03090125
L1, L10..L19	Magnetspule, DHI 24V DC	03240021
LV	Nivellerungspendel, 2x1° + 2x10°	03410601
M1	El-motor, ABB MT906 L24 FT130	03300030
P1	Steckdose	03420027
P6	Stunden zähler 12/48V HCD, 30050269	03090131
Q1	Schalterblock, cage clamp, 3SB3403-0C	03090119
Q2	Schaltblock, ZB2-BE102 BR.	03430004

Dia No : 04015606

Zeichner : MSG

Billigung : CTJ REGSTRUP AUT

Datum : 08-05-02

Revision :

Seite: 5

á 6

STÜCKLISTE

Lift type :
 No : 12503
 Extra ausrüstung :

Denka Lift A/S
 Højvang 5
 DK-4300 Holbæk
 e-mail: INFO@DENKA.dk
 Tel. +45 59 45 55 00
 Fax. +45 59 44 21 55

Pos.	Benennung	Teil nr.
Q3, Q4	Schaltblock 2 abbrechen, ZB4BZ104	03090121
S2..S7	Schaltblock, 2 tempo XEN.G1191	03430090
S8	Schaltblock, ZB2-BE101 SL.	03430003
S9	Schaltblock 1 schluss, ZBE101	03090122
SR1	Collector, 2701 f.schleifring 220V	03460001
SR2	Collector, 2702 f.schleifring 24V	03460002
Side 4	Licht untergestell	12015922
T1	Stromvers. 120W 5A 24VDC, ABL6RF2405	03090126
X1	Klemme, AKZ 4mm ² DIN 15	03440014
X2	Klemme, 4/35 doppelt	03440052
X3, X14	Erdklemme, PA66116	03440044
X4	Ladesteckdose m. deckel	03420500
X6	Vielfachsteckklemme 45 SMSTB 2, 3/14	03420112
X8	Haus for 16 pol mutistik, 70.325. 1628.0	03090129
X9	Einsatzhülse 16 pol 400V 16 amp., 70.300.1640.0	03090130
X10	Klemmeeinsatz, 2,5mm ²	03440046
X11	Vielfachsteck Einsatz, (buchseneinsatz)09210073131	03420510
X12	Vielfachsteck Einsatz, (stifteinsatz) 09210073031	03420511
b1, b3, b5	Drücktaste, schwarz XAC-A9412	03430044
b2, b4, b6	Drücktaste, weiss XAC-A9411	03430043
b7	Notschalter, ZA2-BS834	03430077
b8	Drücktaste, grün XAC-A9413	03430045
b9	Notschalter 40mm, 3SB35001HA20	03090118
b10	Schlüsselschalter 0/schloss/schloss aus links, ZB4BG9	03090120

Dia No : 04015606

Zeichner : MSG

Billigung : CTJ REGSTRUP AUT

Datum : 08-05-02

Revision :

Seite: 6

á 6